



Qualität, Funktionalität und Beständigkeit – das waren und sind wesentliche Vorteile der Serie Taurus GRANIT. Die breite Produktpalette, die an die Serien ColorONE und ColorTWO anknüpft, unterstützt das kreative und variable Potential individueller Projekte, einschließlich einer Reihe von Sonderzubehör. Alle Oberflächen erfüllen die hohen technischen Anforderungen der internationalen Normen.

„Bewährte Qualität.“









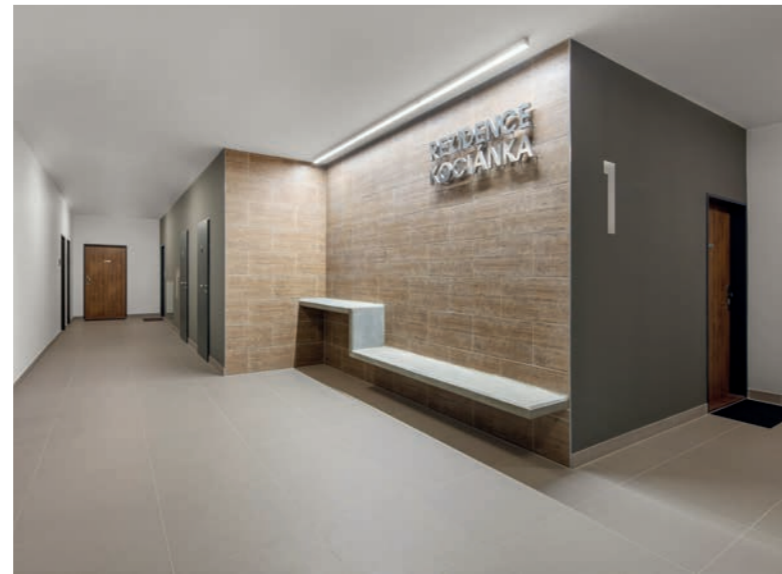





Quality, functionality, and durability were and are the important benefits of the Taurus GRANIT series. The wide range, building on the ColorONE and ColorTWO assortments, supports the creative and variable potential of the individual projects, including a range of special supplies. All surfaces meet the high technical requirements of international standards.

„Proven quality.“





Produkt product			
STO No. 030 - 059824	Duschtasseneckstein shower piece corner	Duschtassenstein shower piece continuous	Hohlkehlsokkel-Rinne skirting groove
	10×10	10×10	20×7
	98×98×8	98×98×8	198×70×8
Oberfläche surface	ABS	ABS	S
Rutschfestigkeit slip resistance	R10/B	R10/B	
Reibungskoeffizient - trocken sliding friction coefficient - dry	$\mu \geq 0,6$	$\mu \geq 0,6$	
Farbe color			
69 Rio Negro schwarz black	TTR11069 ○ 200 St	TTP11069 ○ 200 St	TSZEF069 ○ 140 St
65 Antracit anthrazit-grau anthracite-grey	TTR11065 ○ 200 St	TTP11065 ○ 200 St	TSZEF065 ○ 140 St
76 Nordic grau grey	TTR11076 ○ 200 St	TTP11076 ○ 200 St	TSZEF076 ○ 140 St
78 Sierra hellgrau light grey			
60 Alaska weiß white			
62 Sahara beige beige			
61 Tunis dunkelbeige dark beige	TTR11061 ○ 200 St	TTP11061 ○ 200 St	TSZEF061 ○ 140 St
68 Cuba braun-grau brown-grey			
74 Gobi gelb yellow			
82 Jura rot red			
80 Oaza grün green			
75 Biskay blau blue			
logistische Daten logistic information			
	16	16	24
	100,0	100,0	71,0
	0,16	0,16	0,34
	-	-	-
	-	-	-
	3,5	3,2	7,2
	-	-	21,2
	-	-	-



Farben | colors

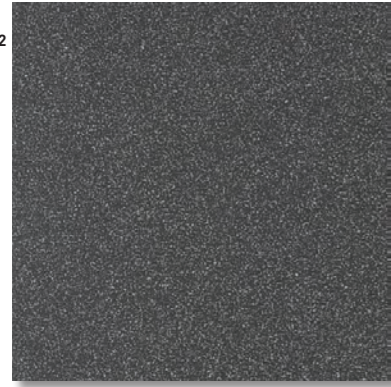
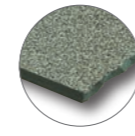

69 Rio Negro
schwarz | black



65 Antracit
anthrazit-grau | anthracite-grey



76 Nordic
grau | grey



68 Cuba
braun-grau | brown-grey



74 Gobi
gelb | yellow



82 Jura
rot | red

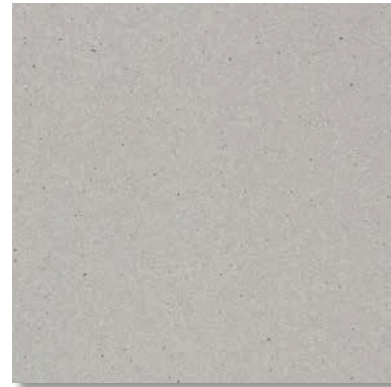

78 Sierra
hellgrau | light grey



60 Alaska
weiß | white

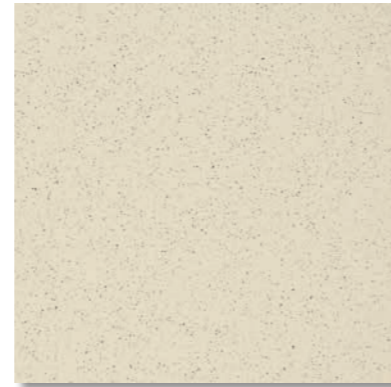

62 Sahara
beige | beige



80 Oaza
grün | green

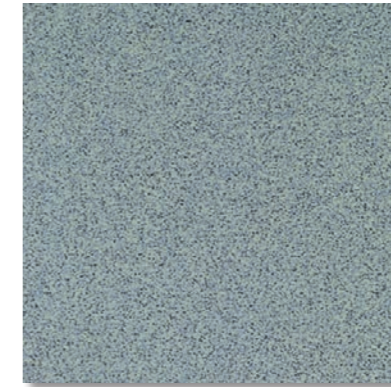

75 Biskay
blau | blue



61 Tunis
dunkelbeige | dark beige



Oberflächen | surfaces



ABS R10/B
μ ≥ 0,6



relief SR7 R11/B
μ ≥ 0,7



relief SRM R12/B
μ ≥ 0,7

ABS... - Glatte rutschhemmende Oberfläche R10/B | Smooth slip-resistant surface R10/B
SR... - Reliefoberfläche | Relief surface



Stufe | step tile | **TCPSE...** | 298x598x10 mm |

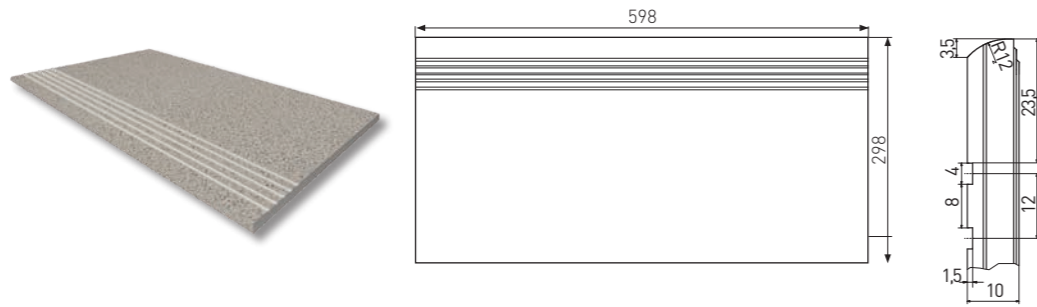

Stufe | step tile | **TCA34...** | 298x298x8 mm |

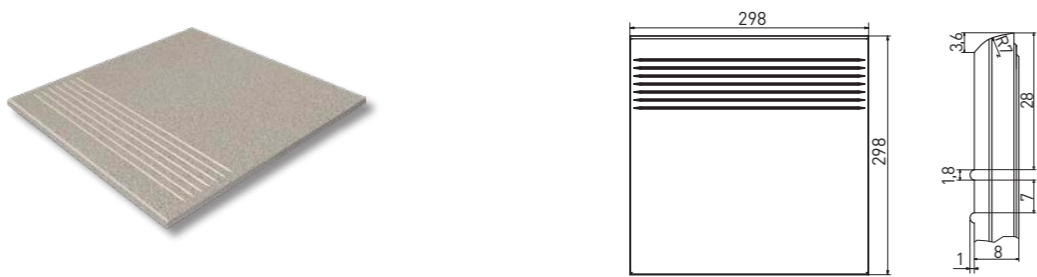

Außenstufe | outside step tile | **TCV34...** | 298x298x8 mm

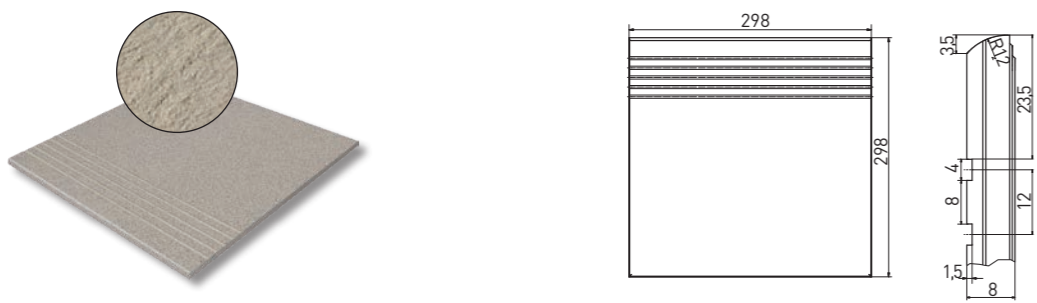

Socket | skirting plinth | **TSASZ...** | 598x95x10 mm |

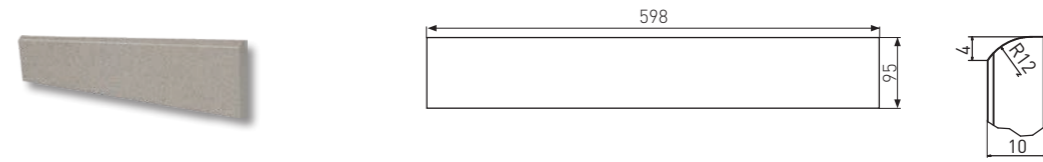

Socket | skirting plinth | **TSAKF...** | 298x80x8 mm |

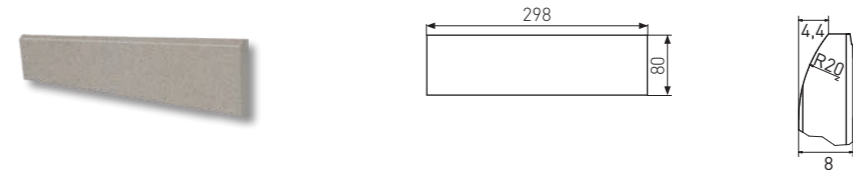

Französischer Socket | french skirting | **TSFKF...** | 298x80x8 mm |

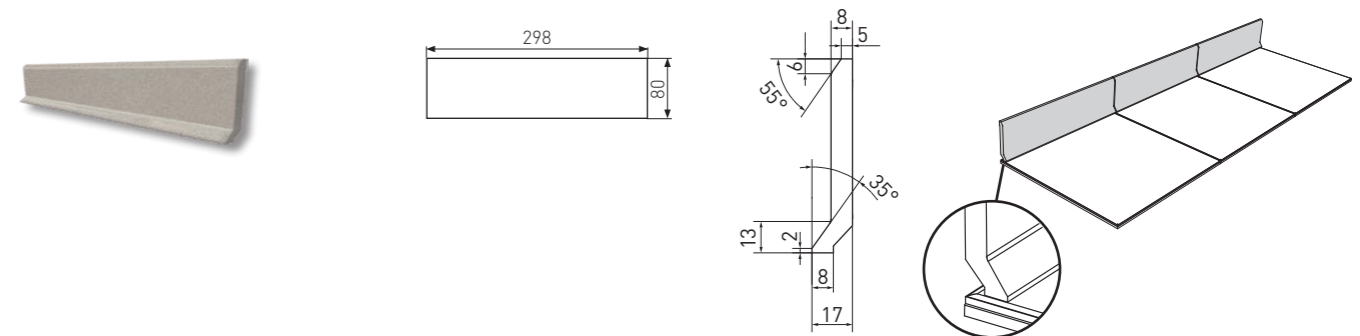



Formteile | special pieces

Hohlkehlsokkel | cove skirting | **TSPKF...** | 298x80x8 mm |

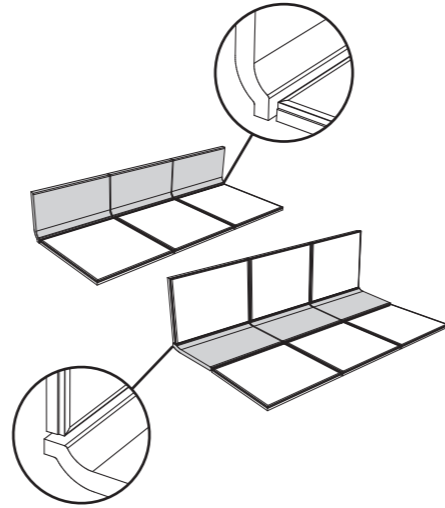
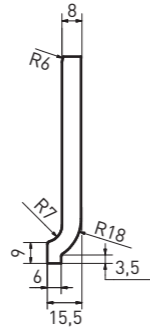
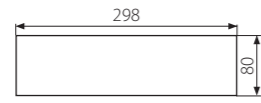

Innenecke Hohlkehlsokkel | inside corner cove skirting | **TSIRH...** | 80x23x10 mm

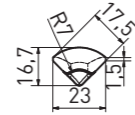
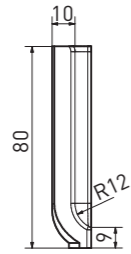

Außenecke Hohlkehlsokkel | outside corner cove skirting | **TSERH...** | 80x23x7 mm

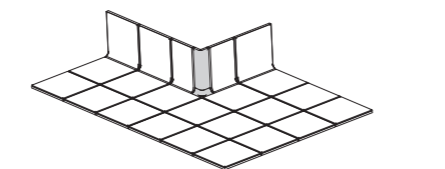
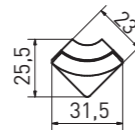
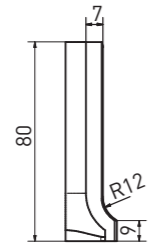

Hohlkehlsokkel | cove skirting | **TSPF6...** | 198x80x8 mm |

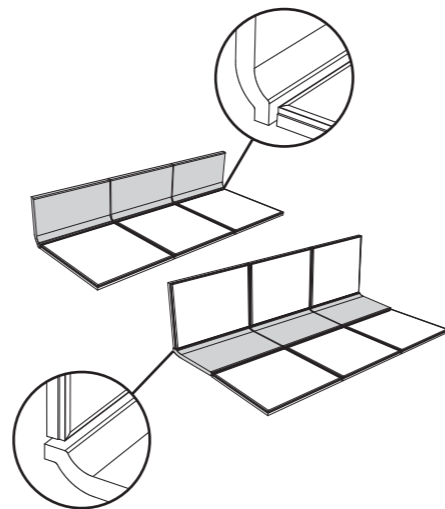
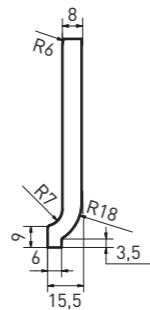
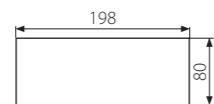

Duschtasseneckstein | shower piece - corner | **TTR11...** | 98x98x8 mm |

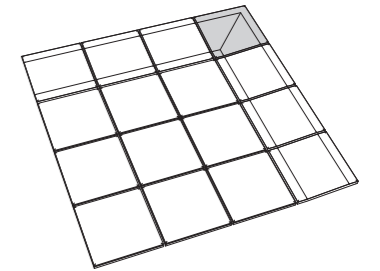
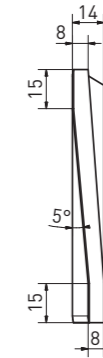
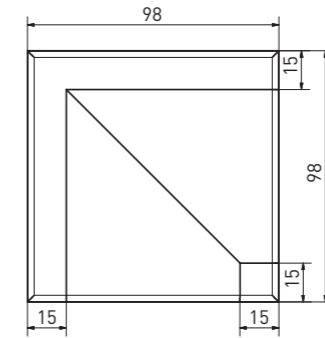
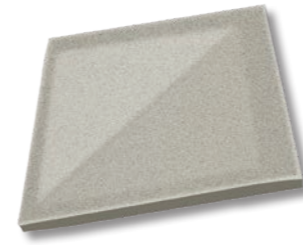

Duschtassenstein | shower piece - continuous | **TTP11...** | 98x98x8 mm |

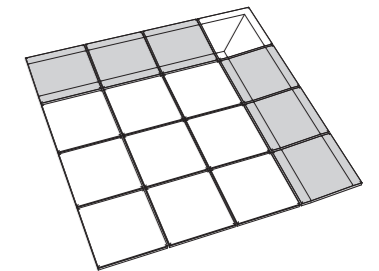
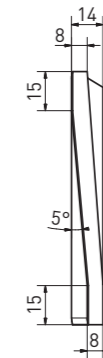
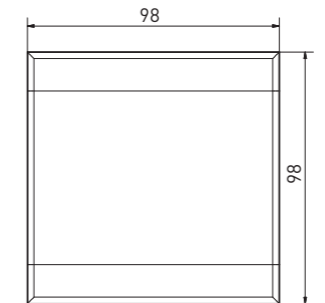

Hohlkehlsokkel-Rinne | skirting - groove | **TSZEF...** | 198x70x8 mm

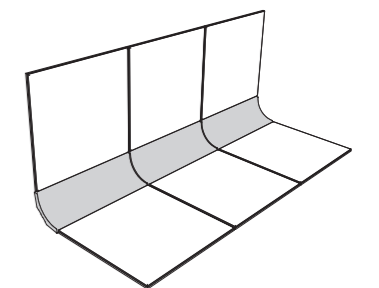
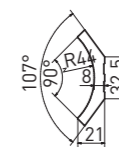
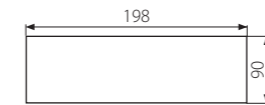

Formteile | special pieces