





60x120

R9

A

V3

R

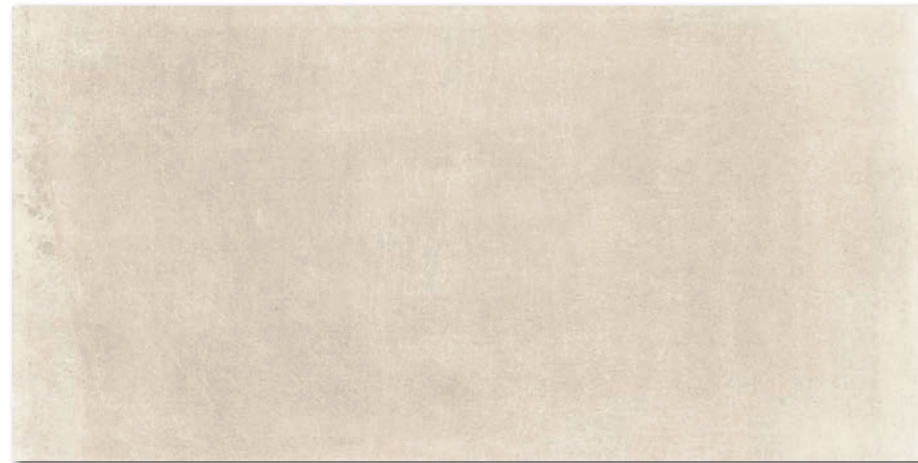

DAKV1743  
PEI 5  $\odot$  87 | m<sup>2</sup>  
mat | matt  
běžová | beige



DAKV1740  
PEI 5  $\odot$  87 | m<sup>2</sup>  
mat | matt  
bílošedá | white-grey

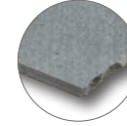

60x120

R9

A

V3

R



DAKV1741  
PEI 5  $\odot$  87 | m<sup>2</sup>  
mat | matt  
šedá | grey



DAKV1742  
PEI 4  $\odot$  87 | m<sup>2</sup>  
mat | matt  
tmavě šedá | dark grey



60x120



598x1198x10



EN 14411 - G B1a



2



1,4



1,44



27



38,88



32,7



22,7



908

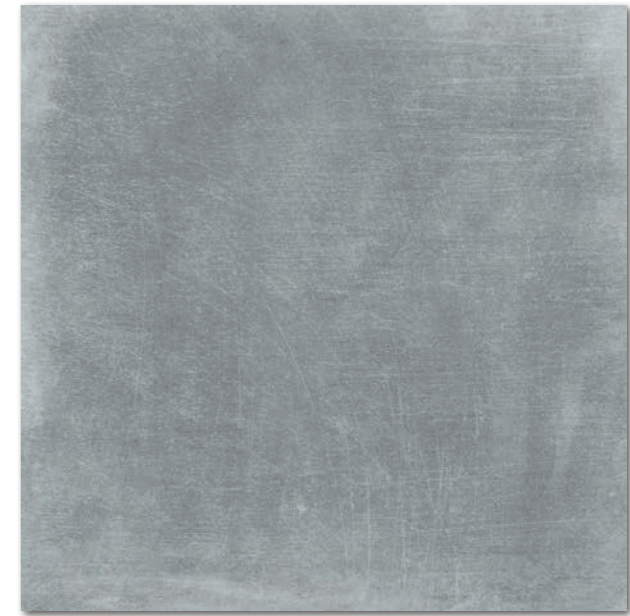
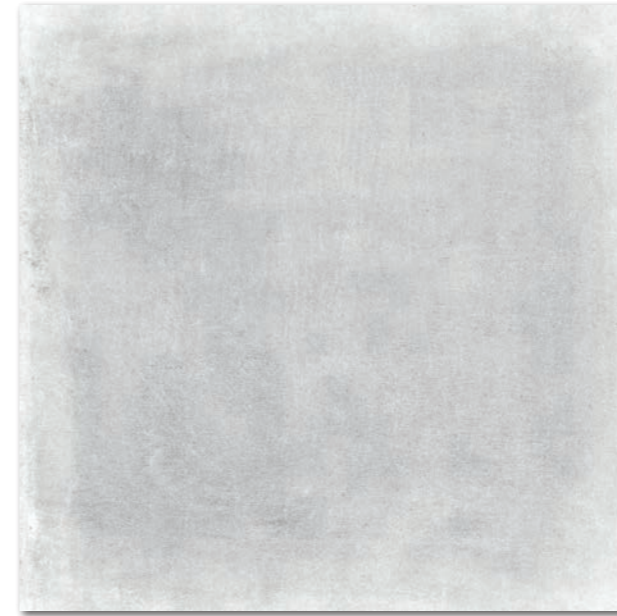
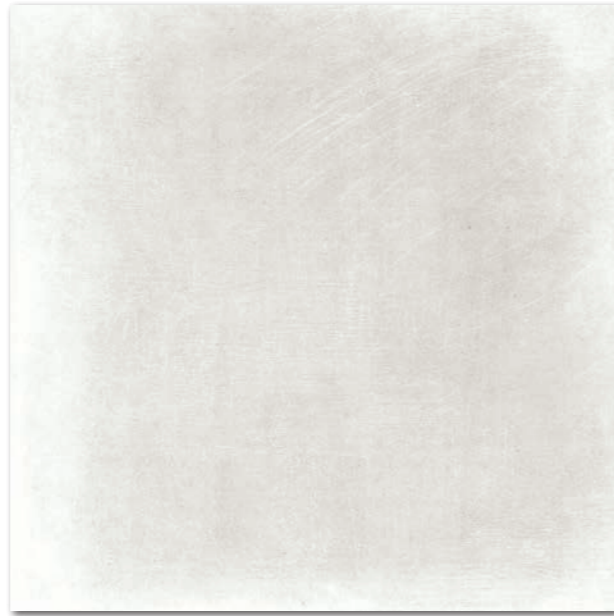
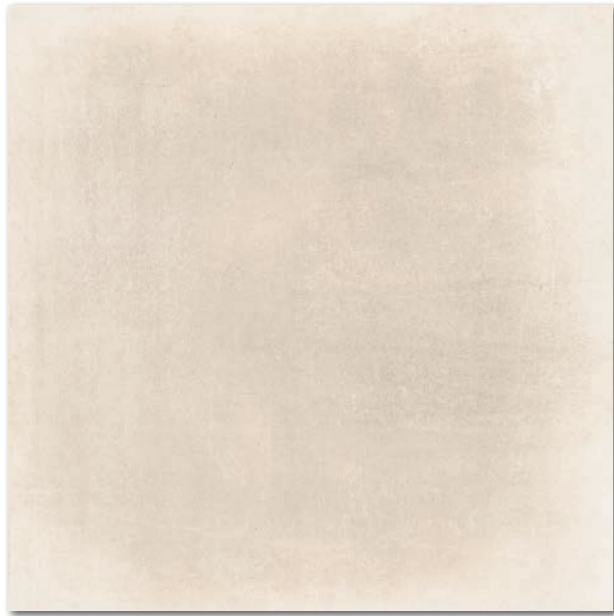
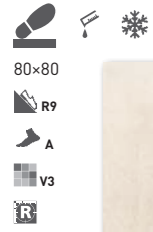

DAK81743  
PEI 5 ○ 83 | m<sup>2</sup>  
mat | matt

DAK81740  
PEI 5 ○ 83 | m<sup>2</sup>  
mat | matt

DAK81741  
PEI 5 ○ 83 | m<sup>2</sup>  
mat | matt

DAK81742  
PEI 4 ○ 83 | m<sup>2</sup>  
mat | matt

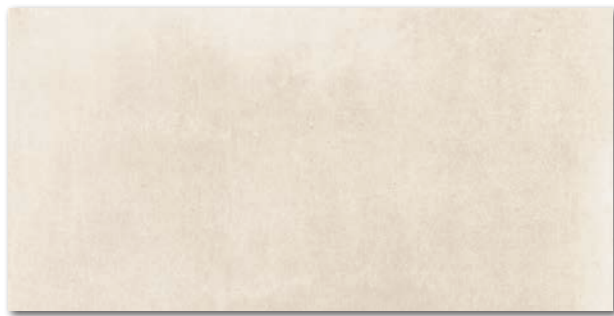

DAK84743  
PEI 5 ○ 83 | m<sup>2</sup>  
mat | matt  
běžová | beige

DAK84740  
PEI 5 ○ 83 | m<sup>2</sup>  
mat | matt  
bílošedá | white-grey

DAK84741  
PEI 5 ○ 83 | m<sup>2</sup>  
mat | matt  
šedá | grey

DAK84742  
PEI 4 ○ 83 | m<sup>2</sup>  
mat | matt  
tmavě šedá | dark grey

výrobek | product



80-80	798-798-10	EN 14411 - G Bla	2	1,6	1,28	42	53,76	28,0	21,9	1 202
dlaždice   floor tile	40-80	398-798-10	4	3,1	1,28	42	53,76	28,0	21,9	1 202

Doporučené skladby formátů viz str. 500-501. | Recommended combinations of modular sizes see pages 500-501.



60x60  
R9  
A  
V3  
R

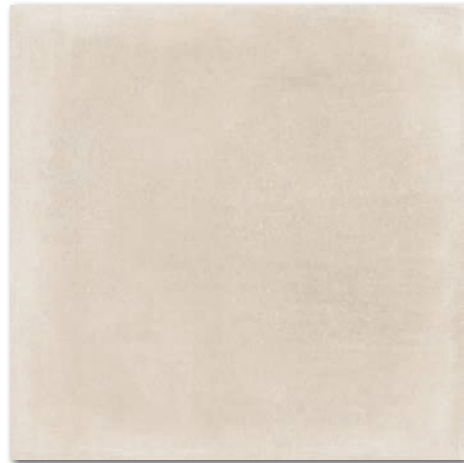

DAK63743  
PEI 5 80 l m<sup>2</sup>  
mat | matt



DAK63740  
PEI 5 80 l m<sup>2</sup>  
mat | matt

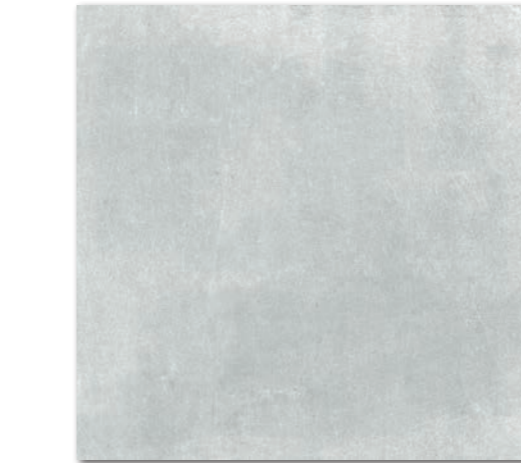

DAK63741  
PEI 5 80 l m<sup>2</sup>  
mat | matt

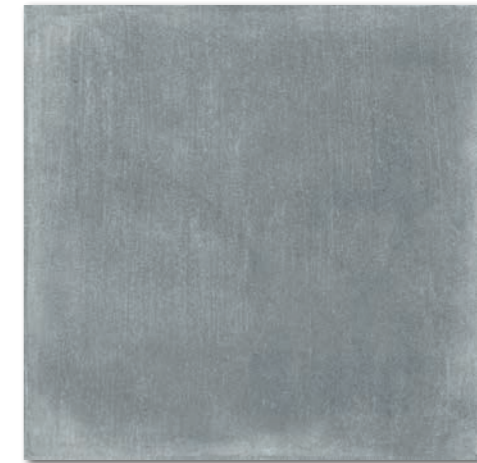

DAK63742  
PEI 4 80 l m<sup>2</sup>  
mat | matt



60x60  
R9  
A  
V3  
R

30x60

R9  
A  
V3  
R



DAKSE743  
PEI 5 80 l m<sup>2</sup>  
mat | matt

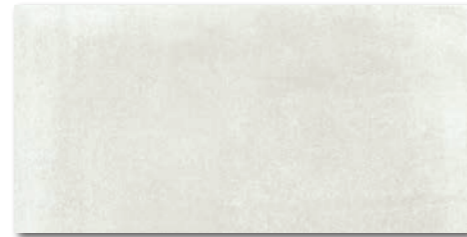

DAKSE740  
PEI 5 80 l m<sup>2</sup>  
mat | matt



DAKSE741  
PEI 5 80 l m<sup>2</sup>  
mat | matt



DAKSE742  
PEI 4 80 l m<sup>2</sup>  
mat | matt

30x60

R9  
A  
V3  
R

45x45

R9  
A  
V3



DAA4H743  
PEI 5 74 l m<sup>2</sup>  
mat | matt  
běžová | beige



DAA4H740  
PEI 5 74 l m<sup>2</sup>  
mat | matt  
bílášedá | white-grey



DAA4H741  
PEI 5 74 l m<sup>2</sup>  
mat | matt  
šedá | grey

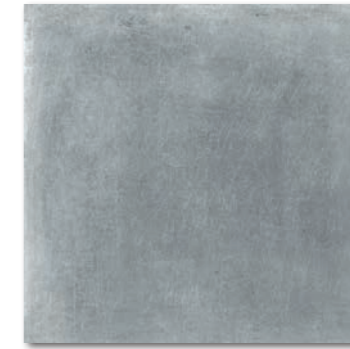

DAA4H742  
PEI 4 74 l m<sup>2</sup>  
mat | matt  
tmavě šedá | dark grey

45x45

R9  
A  
V3

výrobek | product



EN



ks/m<sup>2</sup>

m<sup>2</sup>



m<sup>2</sup>



kg

kg/m<sup>2</sup>

brutto kg

výrobek   product	60x60	30x60	45x45	598x598x10	298x598x10	448x448x8	EN 14411 - G Bla	EN 14411 - G Bla	EN 14411 - G Bla	3	6	6	2,8	5,6	5	1,08	1,08	1,21	32	40	34	34,56	43,20	41,14	23,7	23,7	21,1	21,9	21,9	17,4	782	971	971
dlaždice   floor tile	60x60	30x60	45x45	598x598x10	298x598x10	448x448x8	EN 14411 - G Bla	EN 14411 - G Bla	EN 14411 - G Bla	3	6	6	2,8	5,6	5	1,08	1,08	1,21	32	40	34	34,56	43,20	41,14	23,7	23,7	21,1	21,9	21,9	17,4	782	971	971

Doporučené skladby formátů viz str. 500-501. | Recommended combinations of modular sizes see pages 500-501.



DAK26743  
PEI 5 ○ 90 | m<sup>2</sup>  
mat | matt | R9 | A |

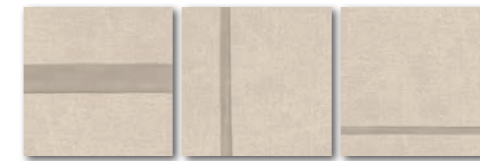

DDT26743  
○ 46 | ks  
matlesk | mattlglossy |



DAK12743 (SET)  
PEI 5 ○ 94 | m<sup>2</sup>  
mat | matt | R10 | B | > |



DDM06743 (SET)  
PEI 5 ○ 72 | set  
mat | matt | R10 | B | > |

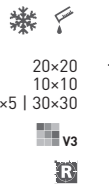

běžová | beige



DAK26740  
PEI 5 ○ 90 | m<sup>2</sup>  
mat | matt | R9 | A |



DDT26740  
○ 46 | ks  
matlesk | mattlglossy |

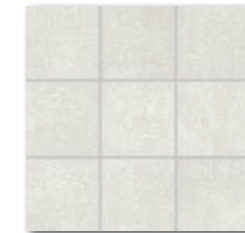

DAK12740 (SET)  
PEI 5 ○ 94 | m<sup>2</sup>  
mat | matt | R10 | B | > |

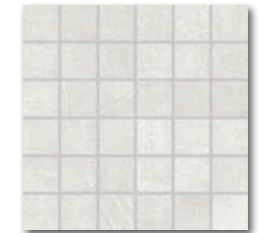

DDM06740 (SET)  
PEI 5 ○ 72 | set  
mat | matt | R10 | B | > |

bílošedá | white-grey



DAK26741  
PEI 5 ○ 90 | m<sup>2</sup>  
mat | matt | R9 | A |



DDT26741  
○ 46 | ks  
matlesk | mattlglossy |

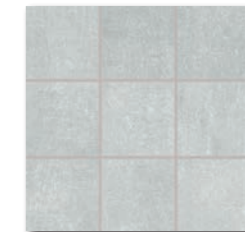

DAK12741 (SET)  
PEI 5 ○ 94 | m<sup>2</sup>  
mat | matt | R10 | B | > |

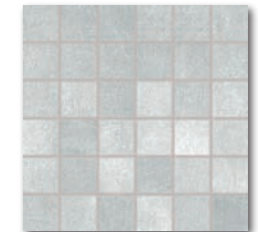

DDM06741 (SET)  
PEI 5 ○ 72 | set  
mat | matt | R10 | B | > |

šedá | grey



DAK26742  
PEI 4 ○ 90 | m<sup>2</sup>  
mat | matt | R9 | A |



DDT26742  
○ 46 | ks  
matlesk | mattlglossy |

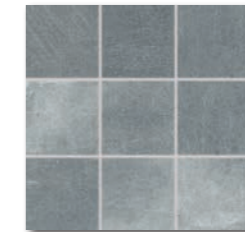

DAK12742 (SET)  
PEI 4 ○ 94 | m<sup>2</sup>  
mat | matt | R10 | B | > |

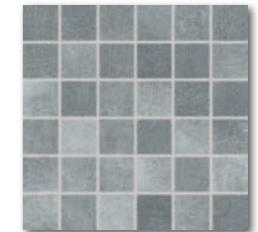

DDM06742 (SET)  
PEI 4 ○ 72 | set  
mat | matt | R10 | B | > |

tmavě šedá | dark grey

výrobek   product	cm	mm	EN	ks/m <sup>2</sup>	m <sup>2</sup>	m <sup>2</sup>	kg	kg/m <sup>2</sup>	brutto kg		
dlaždice   floor tile	20×20	197×197×10	EN 14411 - G Bla	23	25	0,92	57	52,44	20,1	21,9	1 174
dekor   decor	20×20	197×197×10	EN 14411 - G Bla	3	25	0,12	-	-	2,6	21,9	-
dlaždice   floor tile	10×10	98×98×10	EN 14411 - G Bla	10	11	0,91	56	50,96	19,9	21,9	1 142
mozaika set 30×30 cm   mosaic sheet 30×30 cm	5×5	48×48×10	EN 14411 - G Bla	3	11	0,27	-	-	5,9	21,9	-

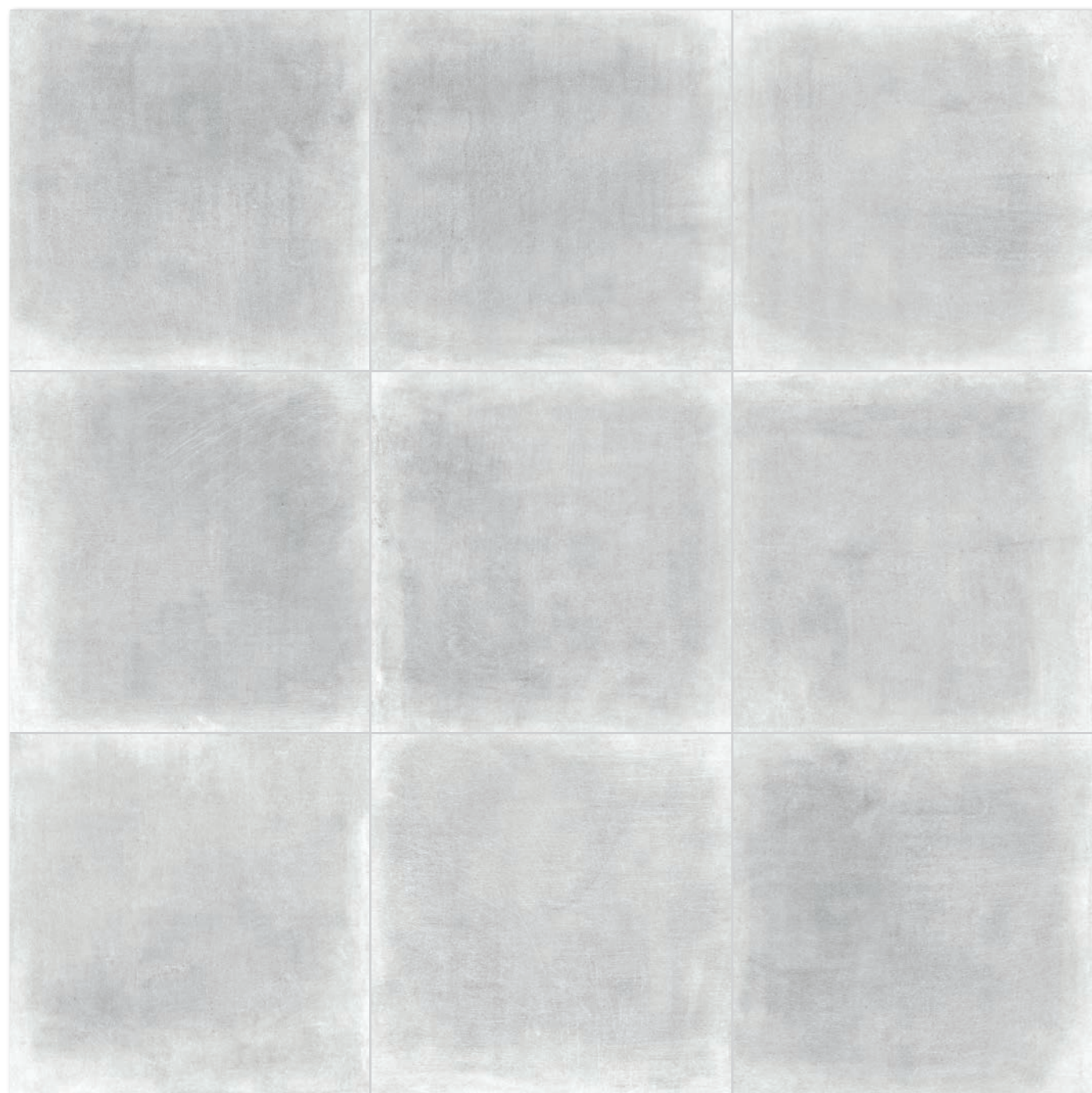

Všechny výrobky celé série vykazují velké odchylky odstínové difference V3. | All products of the entire batch show big deviations in shade difference V3.

Před pokládkou doporučujeme jednotlivé obkladové prvky vybírat z několika kartonů a výslednou plochu komponovat podle inspirativní fotodokumentace z katalogů RAKO případně z webových stránek www.rako.cz. Žadoucí je kombinace všech jednotlivých designů obkladových prvků včetně jejich natáčení o 90° nebo 180° tak, aby bylo dosaženo vyváženého vzhledu obkládané plochy.

Before laying the tiles, we suggest you select from several cartons and arrange them as illustrated in the inspiration photo documentation in RAKO catalogues or website www.rako.eu, and mix the tiles to achieve the required result including turning them by 90° or 180°.

výrobek   product	cm	mm	EN	ks/m <sup>2</sup>	ks/m <sup>2</sup>	m <sup>2</sup> /ks	ks/m <sup>2</sup>	kg/m <sup>2</sup>	brutto kg
schodovka   step tile	30x120	298x1198x10	STO č. 030 - 059824	3/5	2,8	1,08/1,8	-	24,6/40,9	22,7
schodovka   step tile	40x80	398x798x10	STO č. 030 - 059824	2	3,1	0,64	-	14,1	21,9
schodovka   step tile	30x60	298x598x10	STO č. 030 - 059824	6	5,6	1,08	40	23,7	21,9
sokl   skirting plinth	80x9,5	798x95x10	STO č. 030 - 059824	10	13,2	0,76	-	16,7	21,9
sokl   skirting plinth	60x9,5	598x95x10	STO č. 030 - 059824	13	17,5	0,74	-	16,2	21,9
sokl   skirting plinth	45x8,5	448x85x8	STO č. 030 - 059824	25	26,1	0,96	-	16,7	17,4
schodová tvarovka   special step tile	40x80	398x798x10	STO č. 030 - 059824	2	-	-	-	-	-
schodová tvarovka   special step tile	30x120	298x1198x10	STO č. 030 - 059824	2	-	-	-	-	-

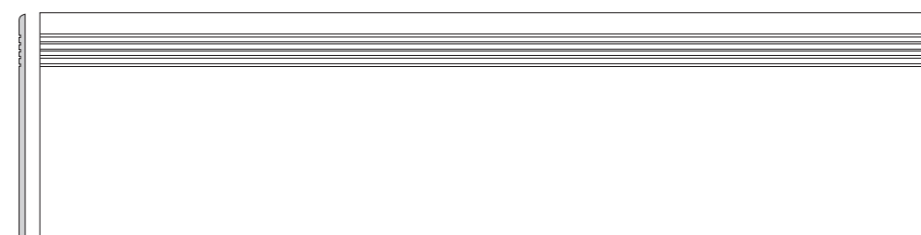

DCPVF740 bílošedá | white-grey  
DCPVF741 šedá | grey  
DCPVF742 tmavě šedá | dark grey  
DCPVF743 béžová | beige  
PEI 4-5 ○ 86 | ks  
mat | matt

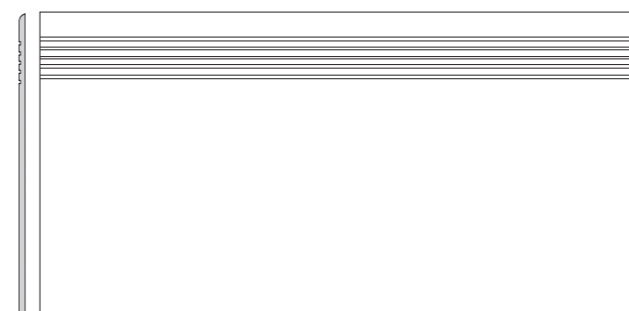

DCP84740 bílošedá | white-grey  
DCP84741 šedá | grey  
DCP84742 tmavě šedá | dark grey  
DCP84743 béžová | beige  
PEI 4-5 ○ 78 | ks  
mat | matt



DCPSE740 bílošedá | white-grey  
DCPSE741 šedá | grey  
DCPSE742 tmavě šedá | dark grey  
DCPSE743 béžová | beige  
PEI 4-5 ○ 72 | ks  
mat | matt



DSA89740 bílošedá | white-grey  
DSA89741 šedá | grey  
DSA89742 tmavě šedá | dark grey  
DSA89743 béžová | beige  
○ 72 | ks  
mat | matt



DSAS4740 bílošedá | white-grey  
DSAS4741 šedá | grey  
DSAS4742 tmavě šedá | dark grey  
DSAS4743 béžová | beige  
○ 56 | ks  
mat | matt



DSAPS740 bílošedá | white-grey  
DSAPS741 šedá | grey  
DSAPS742 tmavě šedá | dark grey  
DSAPS743 béžová | beige  
○ 54 | ks  
mat | matt



DCF84740 bílošedá | white-grey  
DCF84741 šedá | grey  
DCF84742 tmavě šedá | dark grey  
DCF84743 béžová | beige  
PEI 4-5 ○ 108 | ks  
mat | matt

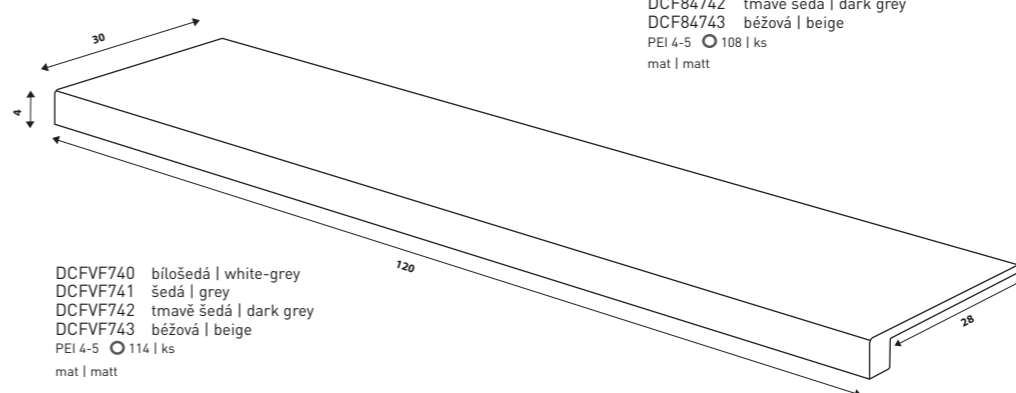

DCFVF740 bílošedá | white-grey  
DCFVF741 šedá | grey  
DCFVF742 tmavě šedá | dark grey  
DCFVF743 béžová | beige  
PEI 4-5 ○ 114 | ks  
mat | matt

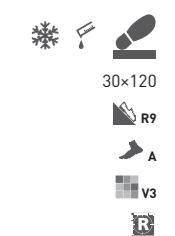

30x120



40x80



80x9,5

60x9,5

45x8,5

40x80



30x120



NEWS